



NEW ITEMS 2021

LOCOMOTIVES AND WAGONS IN GAUGE H0 AND N





**DISCOVER NUMEROUS NEW PRODUCTS
PACKED WITH FASCINATING DETAILS**

In the 2021 New Items Brochure, BRAWA once again introduces a number of new locomotives and wagons in H0 and N gauges. In H0, for example, the new TRAXX 3 electric locomotive of the BR 147/187 series in the current IC livery of Deutsche Bahn AG will be available from specialist retailers. The BRAWA models feature true-to-the-original ribbed side panels and the BR 147 is faithfully equipped with an illuminated train destination display.

Among the wagons in H0 gauge there are numerous new types, such as the vl passenger coaches of the DB, which were used in numerous variants as veritable workhorses in express train and city express traffic. DB had a total of 780 express train wagons of this type in its fleet. And when it

comes to freight cars, the new SSt 125 heavy-duty wagons – rail giants that were used for unusual transports – will be added to the BRAWA range. These mighty wagons could carry a payload of up to 168 tons, which was distributed over 18 axles. Other new types include the Kds 54/56 powdered container cars, which feature numerous true-to-life details, as well as the K 25 lidded freight car, which were developed in the 1920s to transport moisture-sensitive goods.

In N gauge, BRAWA is introducing three new variants of the BR 132 diesel locomotive, which was put into service by the East-German Deutsche Reichsbahn from 1974 and proved to be extremely reliable and versatile. We hope you will enjoy discovering all these fascinating details!



BRAWA HAS EXCITING NEWS FOR 2021



02 GAUGE H0

- 02 Steam locomotives
- 04 Electric locomotives
- 07 Diesel locomotives

08 Passenger coaches

- 30 Freight cars
- 60 Accessories



62 GAUGE N

- 62 Diesel locomotives



© H. DAHLHAUS

You Tube

Want to find out more about the fascination of model railways? Visit our YouTube channel with workshop reports and driving scenes of many models.



NEW LOCOMOTIVES IN PROVEN BRAWA QUALITY

TRAXX 3 ELECTRIC LOCOMOTIVE BR 147 / 187

The product designation TRAXX 3 from Bombardier Transportation reflects the continued development of the well-known TRAXX 2 locomotives of the 146 and 185 series. The new vehicles include the 147 series, for passenger and long-distance traffic, and the 187 series for goods traffic. In addition to the changed appearance of the front, which now consists largely of GRP parts, customers can order a last-mile module for the TRAXX 3 platform if desired. This allows these vehicles, which are designed as

electric locomotives, to run on short sections of track or perform shunting work independently with a diesel engine or under battery power. The first test drives with the new TRAXX 3 locomotives took place shortly after their unveiling in 2011. Thanks to many smaller and some large orders, including a framework agreement for 450 units with DB AG, well over 200 locomotives of the TRAXX 3 platform have been delivered to customers to date and are currently in service throughout Europe.

- New case with ribbed side panels
- New front
- Illuminated train destination display (BR147)
- Etched treadplates
- LED lighting
- Windscreen wipers attached individually

- Traction tyres
- Driver's cab lighting switchable like the original
- Long-distance headlights raise like the original
- Smooth, steady setting off even at speed level 1
- Simple, cable-free dismantling of the housing possible as well as non-twist locking lugs

- True-to-original rest position of the pantographs
- Setting off and braking delay like the original
- Metal frame
- Many attached grip rails
- Chassis with free view

Technical functions	Analog BASIC+ =	Digital EXTRA =	Digital EXTRA ~
Driving function	+	+	+
Light change	+	+	+
Tail lights separately switchable	+	+	+
Driver cabin lighting	+	+	+
Shunting lights	+	+	+
Long-distance headlights	+	+	+
Destination indicator (model dependent)	+	+	+
Digital interface	PluX22	PluX22	PluX22
Decoder		+	+
Sound		+	+
Additional information	<ul style="list-style-type: none"> • Optimised light control for driving and shunting modes • Subsequent conversion from analog to digital via PluX22 interface possible 	<ul style="list-style-type: none"> • Optimised light control for driving and shunting modes • Latest sound technology and excellent sound quality • Compatible with and programmable in all common digital systems (DCC, Motorola, SX1 and SX2) • Improved motor and load control 	

¹⁾ Function only available in digital mode



Order no. **43810** Analog BASIC+ =

Order no. **43812** Digital EXTRA = D&H

Order no. **43813** Digital EXTRA ~ D&H



Electric Locomotive BR 147 DB AG
See our website for road no.

DELIVERY DATE: SEE OUR WEBSITE



Order no. **43814** Analog BASIC+ =

Order no. **43816** Digital EXTRA = D&H

Order no. **43817** Digital EXTRA ~ D&H



Electric Locomotive BR 147.5 DB AG
See our website for road no.

DELIVERY DATE: SEE OUR WEBSITE



Order no. **43818** Analog BASIC+ =

Order no. **43820** Digital EXTRA = D&H

Order no. **43821** Digital EXTRA ~ D&H



Electric Locomotive BR 187 DB AG
See our website for road no.

DELIVERY DATE: SEE OUR WEBSITE





CENTRE-DOOR COACH FOR THE CITY EXPRESS TRAFFIC

YL PASSENGER COACHES DB



© REINHOLD PALM, SLG. EISENBAHMUSEUM

The 26.4 m express train wagons were introduced before the express coaches of the same length. Around 1950, DB, together with a number of wagon factories under the management of the Wegmann company, began development of new four-axle passenger carriages for district and long-haul transport at medium distances. After building three test coaches with a length of 26.4 m with central and end doors, the company finally decided on this type of construction. In late 1951 the first order for 500 of these carriages was placed with

15 coachbuilders. In the following years additional orders were placed for 245 units, the delivery of which would drag on until early 1955. The two basic types were the mixed-class AB carriage and the single-class B carriage. On the basis of the latter type, various push-pull train control cars were developed to meet traction requirements for push-pull operations and, for traffic reasons, carriages with luggage compartments or dining areas were also designed.



THE INVENTORY OF STANDARD EXPRESS TRAIN COACH INCLUDES THE FOLLOWING EIGHT TYPES:

260	COACH 1 ST /2 ND CLASS, TYP AB4YMG-51
321	COACH 2 ND CLASS, TYP B4YMG-51
35	COACH 2 ND CLASS WITH KITCHEN AND DINING AREA, TYP BR4YMG-51
51	COACH 2 ND CLASS WITH DRIVER'S CAB, TYP B4YMGF-51
35	COACH 2 ND CLASS WITH KITCHEN AND DINING AREA (WITHOUT CENTRAL DOORS), TYP BR4YMG-51
29	COACH 2 ND CLASS WITH LUGGAGE COMPARTMENTS WITH SIDEWALK AND DRIVER'S CAB, TYP BPW4YMGF-52
38	COACH 2 ND CLASS WITH LUGGAGE COMPARTMENTS AND DRIVER'S CAB, TYP BPW4YMGF-54
10	COACH 1 ST CLASS (WITHOUT CENTRAL DOORS), TYP A4YMG-54
1	LUGGAGE COACH, TYP PW4YMG-54
780	EXPRESS TRAIN COACH

The running gear (Minden/Deutz-type bogie) and the structural design were basically the same for all types. The undercarriage and body frame were a welded sectional steel construction. Special attention was paid to sound and heat insulation, the cost of which had to be kept within reasonable limits, in keeping with the planned use of the carriages in district traffic. The walls and undercarriage were lined with rock wool, the roof with a sprayed insulation consisting of asbestos flakes. Apart from two designs, the carriages were divided into two passenger compartments of different lengths by the central doors, which were actually located slightly off-centre. The central doors featured two relatively narrow revolving doors and a central pillar, while the end doors with their wide revolving doors, whose centre of rotation was moved inwards, and the somewhat more favourable arrangement of the steps allowed convenient entry and exit. Multi-part folding doors formed the end of the front wall, which, when closed, protruded into the vestibule like a box to keep the "Bern rectangle" free.

The seating arrangement in the passenger compartments was 1 + 2 in the upper and 2 + 2 in the lower-class carriage. The toilets were located at the ends of the carriages and protruded into the large vestibules. The interior design of the carriages was relatively simple, but nevertheless dignified. In the first-class areas, the walls and the frames of the upholstered seats were covered with fine wood veneer; in second class, the wall surfaces were coated with plastic wallpaper. The upholstery in the first-class carriage corresponded to the standard design in use by Deutsche Bahn at the time. The second-class carriage was equipped with upholstered double seats covered with imitation leather. The luggage racks in both classes consisted of thin-walled, high-strength tubular steel and were coated with stove enamel in a nickel silver colour.

A high-pressure heating system was installed, which could be regulated in fine degrees by opening and closing heat-insulating flaps. The main steam pipe under the carriage, a common feature in other models, was removed. In addition to the steam heating, a normal electric heater rated for 1,000 volts was installed, whose resistance heating elements were arranged under the seats so that the floor remained unobstructed.

Given the importance of push-pull operations within the framework of the structural transformation of the traction haulage service, as well as the need to unburden the over-utilised (terminus) railway stations, all express train wagons were designed for this purpose and prepared for subsequent installation of the necessary equipment, such as control lines and the main tank air line (8 atmospheres). 118 carriages received driver's cabs. Initially, however, only some of these carriages and the associated piped wagons were fitted with all equipment necessary for operation by remote control.

Located at one end of the carriage, the driver's cabs were completely identical in all three push-pull control car types; the operational requirement to be able to use these carriages freely like normal carriages resulted in a head section with foot bridge. The floor plans show the arrangement of the driver's cab and the conductor's compartment on both sides of the central passageway in the carriage's head section. Two hinged doors with window panes were arranged so that one of them formed the end exterior wall when used as a control car. When used in normal trains it served as the end of the driver's compartment. Analogously, the other door either connected the head section to the interior or served as the end of the driver's cab. This sensible arrangement of the doors allowed free movement from carriage to carriage if necessary.

- True-to-scale reproduction of the windows
- Wheel sets of type 094/096 with corrugated wheel-discs on both sides
- True-to-epoch interior fittings
- Interior lighting prepared or built-in

- Elastic rubber bulge
- NEM-standard short coupling
- Version with riveted roofs and overlapping roof plates
- Alternator on bogie separately mounted

- Fine paintwork and printing
- Extra mounted steps
- Extra mounted handrails



WWW.BRAWA.DE





Order no. **58000** Order no. **58012**

Order no. **58024**

Passenger Coach ABymgf-51 DB
Road no. 30 088 Esn
BD Essen / Dortmund Hbf

DELIVERY DATE: SEE OUR WEBSITE



Order no. **58004** Order no. **58016**

Order no. **58028**

Passenger Coach ABymb 411 DB
Road no. 50 80 30-11 097-9
BD Hamburg / Hamburg Hbf

DELIVERY DATE: SEE OUR WEBSITE



Order no. **58001** Order no. **58013**

Order no. **58025**

Passenger Coach B4ymgf-51 DB
Road no. 40 536 Esn
BD Essen / Dortmund Hbf

DELIVERY DATE: SEE OUR WEBSITE



Order no. **58005** Order no. **58017**

Order no. **58029**

Passenger Coach Bylb 421 DB
Road no. 50 80 21-11 179-6
BD Hamburg / Hamburg Hbf

DELIVERY DATE: SEE OUR WEBSITE



Order no. **58002** Order no. **58014**

Order no. **58026**

Passenger Coach B4ymgf-51 DB
Road no. 40 521 Esn
BD Essen / Dortmund Hbf

DELIVERY DATE: SEE OUR WEBSITE



Order no. **58006** Order no. **58018**

Order no. **58030**

Passenger Coach Bylb 421 DB
Road no. 50 80 21-11 183-8
BD Hamburg / Hamburg Hbf

DELIVERY DATE: SEE OUR WEBSITE



Order no. **58003** Order no. **58015**

Order no. **58027**

Control Car BPw4ymgf-54 DB
Road no. 99 163 Esn
BD Essen / Dortmund Hbf

DELIVERY DATE: SEE OUR WEBSITE



Order no. **58007** Order no. **58019**

Order no. **58031**

Control Car BDymf 456 DB
Road no. 50 80 82-11 009-1
BD Hamburg / Hamburg Hbf

DELIVERY DATE: SEE OUR WEBSITE





Order no. **58008** Order no. **58020**

Order no. **58032**

Passenger Coach AByl 411 DB
Road no. 50 80 30-11 105-0
BD Hannover / Braunschweig Hbf

DELIVERY DATE: SEE OUR WEBSITE



Order no. **58010** Order no. **58022**

Order no. **58034**

Passenger Coach Byl 422 DB
Road no. 50 80 21-11 389-1
BD Hannover / Braunschweig Hbf

DELIVERY DATE: SEE OUR WEBSITE



Order no. **58009** Order no. **58021**

Order no. **58033**

Passenger Coach Byl 422 DB
Road no. 50 80 21-11 272-9
BD Hannover / Braunschweig Hbf

DELIVERY DATE: SEE OUR WEBSITE



Order no. **58011** Order no. **58023**

Order no. **58035**

Passenger Coach Byl 422 DB
Road no. 50 80 21-11 420-4
BD Hannover / Braunschweig Hbf

DELIVERY DATE: SEE OUR WEBSITE



© W. BÜGEL, SLG. EISENBAHNSTIFTUNG





Order no. **45321**

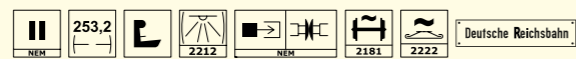

Model: Free-standing handrails; prepared for interior lights; open roof ventilator; extra brake and heating system; with interior fittings; 3-point support; close-coupling; metal springs; fine engraved rivets

Express Train Car BC4ü-30 DRG
Road no. 250 364

DELIVERY DATE: SEE OUR WEBSITE



Order no. **45322**

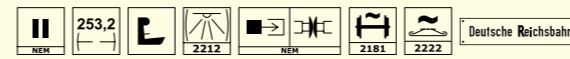

Express Train Car C4ü-30 DRG
Road no. 250 768

DELIVERY DATE: SEE OUR WEBSITE



Order no. **45318**

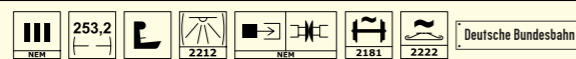

Express Train Car C4ü-30/52 DB
Road no. 250 514

DELIVERY DATE: SEE OUR WEBSITE



Order no. **45317**

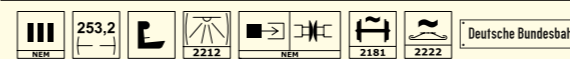

Express Train Car BC4ü-30/52 DB
Road no. 250 344

At the end of the first world war, the state of Poland included new territories which had previously been part of the German Empire, Austria and Russia. The country's railway system reflected this, because it was a patchwork of German, Austrian and Russian technology, though the German influence was greatest. That's why the subsequent development of the Polish railways was closely linked to the development of the German railways. When the Polish State Railway (PKP) began the radical modernisation of its express train stock at the end of the nineteen twenties, for example, it took recourse to earlier German designs. The Deutsche Reichsbahn commissioned a new generation of express train cars from 1920 onwards which were pioneering in a number of ways. They were made entirely out of steel. They also had tapered ends to reduce aerodynamic drag, which is why they were given the name "Hechtwagen" (pike cars) or "Hechte" (pikes). The cars weren't just manufactured for the Deutsche Reichsbahn, but also exported to Bulgaria and Turkey. PKP developed its own cars based on these reliable models and produced them in far greater numbers than the German originals. Logically, they were called "Polish pikes".

DELIVERY DATE: SEE OUR WEBSITE



Order no. **45319**

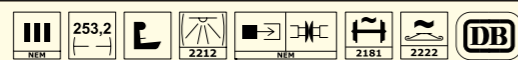

Express Train Car A4ü-30/52 DB
Road no. 250 295

DELIVERY DATE: SEE OUR WEBSITE



Order no. **45320**

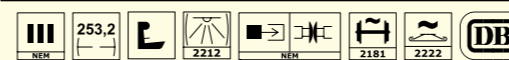

Express Train Car B4ü-30/52 DB
Road no. 250 872

DELIVERY DATE: SEE OUR WEBSITE



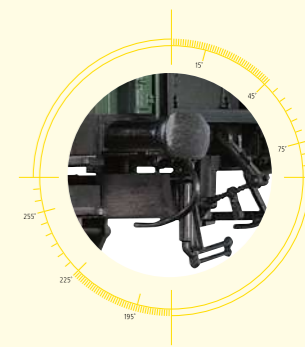

Order no. **45327**

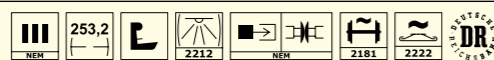

Model: Free-standing handrails; prepared for interior lights; open roof ventilator; extra brake and heating system; with interior fittings; 3-point support; close-coupling; metal springs; fine engraved rivets



Order no. **45328**

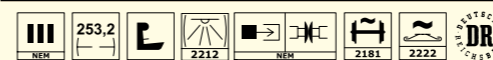

Express Train Car B4ü DR
Road no. 208-219

DELIVERY DATE: SEE OUR WEBSITE

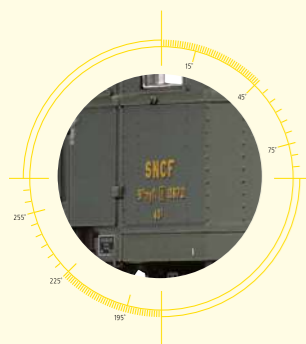

Order no. **45324**

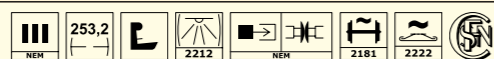

Express Train Car B SNCF
Road no. 13672

DELIVERY DATE: SEE OUR WEBSITE



Order no. **45323**

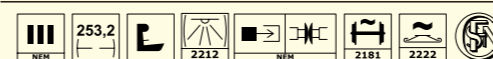

Express Train Car B SNCF
Road no. 13669

DELIVERY DATE: SEE OUR WEBSITE



Order no. **45325**



Express Train Car ABüe 324 DB
Road no. 50 80 39-11 005-3

DELIVERY DATE: SEE OUR WEBSITE



Order no. **45326**

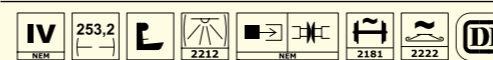

Express Train Car Büe 371 DB
Road no. 50 80 20-11 131-8

DELIVERY DATE: SEE OUR WEBSITE





DELICIOUS DETAILS

DINING COACHES WRGE DR

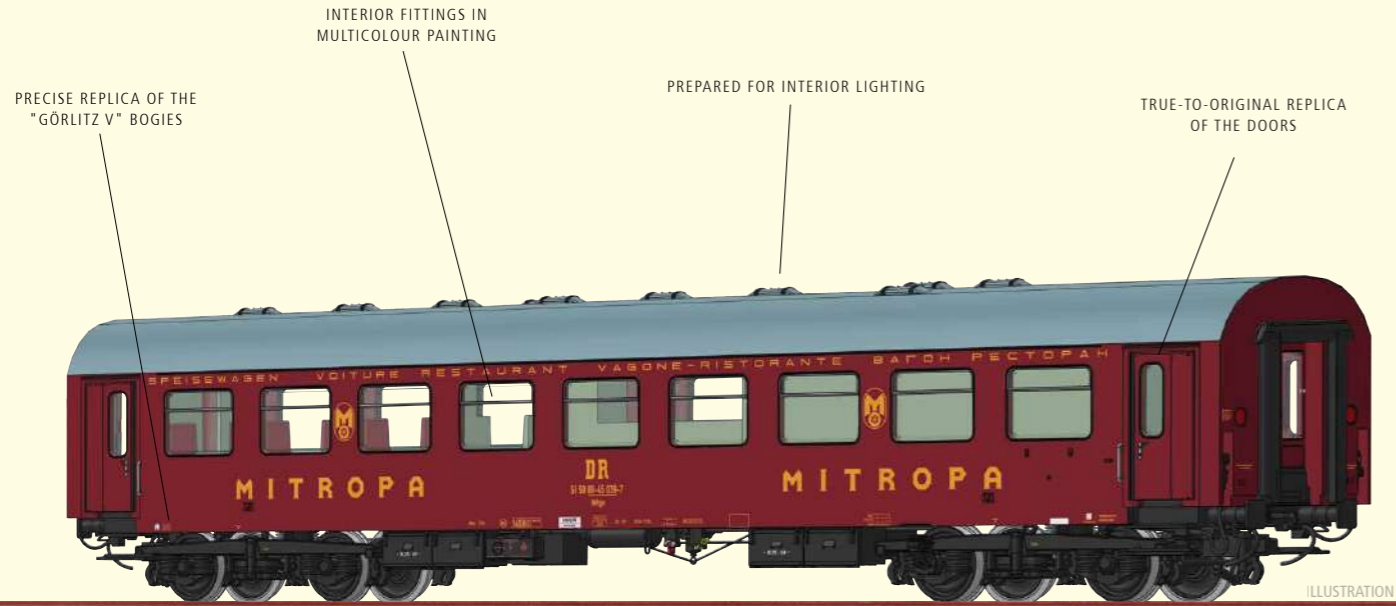

ILLUSTRATION

Dining Coach WRge DR
Road no. 51 50 88-45 039-7

In the early 70ies, the DR planned to improve the gastronomic supply in the domestic express trains. In addition, many of the pre-war restaurant cars still in use were waiting to be taken out of service. The DR therefore considered the procurement of new restaurant cars. Delivery by the wagon building industry of the GDR was not possible for capacity reasons; hence the manufacture in DR repair sheds remained as sole alternative. Although the Mitropa factory in Gotha had constructed six cars from older vehicles as "Reko coaches" already in 1960, a new design on the basis of the Bghw coaches manufactured in Halberstadt was decided. These were built as completely new types and did not comprise any used parts. A total of fifty vehicles designated as WRge emerged into two series in 1973 (20) and 1977 (30). They received the typical wine-red Mitropa paint coating with inscriptions in four

languages, but without the previously used decorative lines. Both series were only different in two windows in the kitchen section which were supposed to improve the lighting conditions in this area. With a maximum velocity of 140 km/h and a multi-voltage heating, the coaches were capable of being used internationally and thus also reached destinations in the FRG and CSSR. After the modification of the major part of the cars, just five original restaurant cars with the red paint were still in operation in 1989. Although the restaurant cars were to receive the new type number 541, they were completely decommissioned by 1993. Due to their short length and the robust furniture and implements, many of them found a new home with museum railway organisations.

DELIVERY DATE: SEE OUR WEBSITE

Order no. **45389**

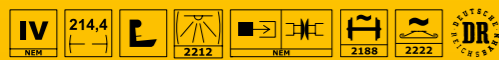

- Printed window frames
- Precise replica of the Görlitz V bogies
- Prepared for interior lighting
- Interior fittings in multicolour painting
- NEM-standard short coupling
- Alternator on bogie separately mounted
- In-plane assembled windows
- Fine paintwork and printing
- Passageway with separately mounted rubber beading



Dining Coach WRg DR
Road no. 51 50 88-15 024-5



Order no. **45390**

DELIVERY DATE: SEE OUR WEBSITE

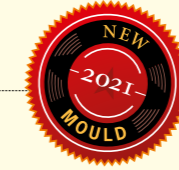

Dining Coach WRge DR
Road no. 51 50 88-45 029-8



Order no. **45391**

DELIVERY DATE: SEE OUR WEBSITE



Dining Coach Wgr DR
Road no. 50 50 87-15 619-4



Order no. **45392**

DELIVERY DATE: SEE OUR WEBSITE

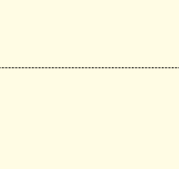

Passenger Coach Bghwe DR
Road no. 57 50 28-25 376-4



Order no. **45377**

AVAILABLE

Passenger Coach Bghwe DR
Road no. 57 50 28-14 471-6



Order no. **45379**

AVAILABLE

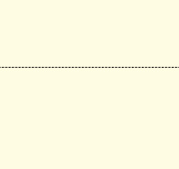

Passenger Coach Bghwe DR
Road no. 50 50 28-14 982-9



Order no. **45385**

DELIVERY DATE: SEE OUR WEBSITE

Passenger Coach Bghwe DR
Road no. 50 50 28-15 457-1



Order no. **45386**

DELIVERY DATE: SEE OUR WEBSITE



RHEINGOLD



Order no. 46430		Order no. 46432	
Order no. 46431		Order no. 46433	

Model: Precise replica of the Görlitz II schwer bogies; metal wheels; three-point support in metal axle support; multi-part and multi-colored interior fittings; individually placed table lamps; short coupling kinematics; finest paintwork and printing; precise replica of the brake unit; originally reproduced frame; all specific details of the different eras taken into account
 Digital version: entry lighting; roof and table lighting

Express Train Car SB4ü DRG
 Road no. 10 706 Köln

Add-on car: digital functions only with Rheingold-set (Order no. 45918 / 45919) controllable.

DELIVERY DATE: SEE OUR WEBSITE



Order no. 46434		Order no. 46436	
Order no. 46435		Order no. 46437	

Express Train Car SB4ük DRG
 Road no. 10 709 Köln

Add-on car: digital functions only with Rheingold-set (Order no. 45918 / 45919) controllable.

DELIVERY DATE: SEE OUR WEBSITE



Order no. **46422**

Express Train Car A4üe-28/52 DB
 Road no. 11 356 Han

DELIVERY DATE: SEE OUR WEBSITE



Order no. **46424**

Express Train Car A4üe-28/52 DB
 Road no. 11 359 Nür

DELIVERY DATE: SEE OUR WEBSITE

Express Train Car B4üe-28/52 DB
 Road no. 11 355 Au

After 1945 at least 16 passenger cars and the three luggage wagons of the Rheingold Express remained with Deutsche Bahn. Since the train no longer ran in its previous form, the carriages were repurposed for different roles. Eight of these were used to create the DSG dining cars 1230, 1232 and 1234 – 1239. Five were converted into normal twin-class compartment carriages 11355 – 11359 and three were used to create the coaches 10801 – 10 803. The luggage wagons retained their role and were taken out of service between 1968 and 1977.

DELIVERY DATE: SEE OUR WEBSITE



Order no. **46421**



Order no. **46425**

Express Train Car WR4ü 28/51 DSG
 Road no. 10 232

DELIVERY DATE: SEE OUR WEBSITE





Order no. **46410** Order no. **46411** Order no. **46412**

Express Train Car B4üe-28/52 der DB
 Road no. 10 702 Au (Order no. 46410)
 Road no. 10 706 Han (Order no. 46411)
 Road no. 10 708 Esn (Order no. 46412)

AVAILABLE AGAIN: SEE OUR WEBSITE



Order no. **46423**

Express Train Car A4üe-28/52 DB
 Road no. 11 357 Ffm

DELIVERY DATE: SEE OUR WEBSITE



Order no. **46426**

Express Train Car Pw4ü-28 DB
 Road no. 105 003 Hmb

DELIVERY DATE: SEE OUR WEBSITE



Order no. **46429**

Express Train Car WR 151 CSD
 Road no. 480

DELIVERY DATE: SEE OUR WEBSITE



Order no. **46427**

Express Train Car Büe 355 DB
 Road no. 51 80 28-43 100-6

DELIVERY DATE: SEE OUR WEBSITE



Order no. **46428**

Express Train Car Aüe 303 DB
 Road no. 51 80 18-43 040-6

DELIVERY DATE: SEE OUR WEBSITE



SILBERLINGE



DEVIATING ROAD NO.

Passenger Coach AB4nb-59 DB
Road no. 31 048 Ksl

DELIVERY DATE: SEE OUR WEBSITE

Order no. 46569		Order no. 46573	
		Order no. 46607	



Passenger Coach ABn 404 DB
Road no. 50 80 31-33 024-6

DELIVERY DATE: SEE OUR WEBSITE

Order no. 46578		Order no. 46582	
		Order no. 46610	



DEVIATING ROAD NO.

Passenger Coach B4nb-59a DB
Road no. 41 159 Ksl

DELIVERY DATE: SEE OUR WEBSITE

Order no. 46570		Order no. 46574	
		Order no. 46608	



Passenger Coach Bn 433 DB
Road no. 50 80 22-03 110-0

DELIVERY DATE: SEE OUR WEBSITE

Order no. 46579		Order no. 46583	
		Order no. 46611	



DEVIATING ROAD NO.

Passenger Coach B4nb-59a DB
Road no. 41 269 Ksl

Although prototypes had also been trialed with side panels made from aluminium, standard steel and corrugated side walls, metal panelling made from stainless steel (V2A) was eventually chosen for mass production. Since the coach paintwork corrosion protection was not required for this material, the n-coaches were abraded under the windows using a peacock eye pattern. This abrading pattern and the silver surface of the V2A quickly earned the n-coach the distinctive nickname "Silberlinge".
DELIVERY DATE: SEE OUR WEBSITE

Order no. 46571		Order no. 46575	
		Order no. 46609	



Passenger Coach Bn 433 DB
Road no. 50 80 22-03 121-7

DELIVERY DATE: SEE OUR WEBSITE

Order no. 46580		Order no. 46584	
		Order no. 46612	



Passenger Coach BPw4nf-59 DB
Road no. 96 214 Ksl

DELIVERY DATE: SEE OUR WEBSITE

Order no. 46572		Order no. 46576	
		Order no. 46577	



Passenger Coach BDnrzf 784.2 DB
Road no. 50 80 82-34 046-6

DELIVERY DATE: SEE OUR WEBSITE

Order no. 46581		Order no. 46585	
		Order no. 46586	





Order no. **46587** Order no. **46591**

Order no. **46613**

Passenger Coach ABn 704 DB AG
Road no. 50 80 31-34 051-8

DELIVERY DATE: SEE OUR WEBSITE



Order no. **46588** Order no. **46592**

Order no. **46614**

Passenger Coach Bnz 723 DB AG
Road no. 50 80 22-35 011-2

DELIVERY DATE: SEE OUR WEBSITE



Order no. **46589** Order no. **46593**

Order no. **46615**

Passenger Coach Bnrz 725 DB AG
Road no. 50 80 22-34 035-2

DELIVERY DATE: SEE OUR WEBSITE



Order no. **46590** Order no. **46594**

Order no. **46595**

Passenger Coach BDnrzf 740 DB AG
Road no. 50 80 82-34 047-4

DELIVERY DATE: SEE OUR WEBSITE



Order no. **46058**

Passenger Coach B4yg DB
Road no. EM 65 012

DELIVERY DATE: SEE OUR WEBSITE



Order no. **46096**

Passenger Coach AB4yg DB
Road no. 34 087 Hmb

DELIVERY DATE: SEE OUR WEBSITE



Order no. **46099**

Passenger Coach BPw4yg DB
Road no. 98 118 Hmb

DELIVERY DATE: SEE OUR WEBSITE



Order no. **46097** Order no. **46098**

Passenger Coach B4yg DB
Road no. 75 544 Hmb (Order no. 46097)
Road no. 75 787 Hmb (Order no. 46098)

DELIVERY DATE: SEE OUR WEBSITE





Passenger Coach Bmhe DR

Road no. 51 50 21-40 035-0
Magdeburg Hbf

Since the railcar industry in the DDR was fully occupied with export orders, HalberstadtRAW was the only shop available for the construction of the new car. Because the facilities there had been expanded by this time, the new vehicle could now fully exploit the UIC measure of 26.4 m. There was a prototype as early as 1973, and a second followed in 1975. Both were tested extensively in daily operations. The name „Langer Halberstädter“ was coined rather quickly in common parlance, making a connection with the famous sausages produced there. While the cars were still in construction, a request came from DR to make the car suitable for „premium international assignments“, which naturally led to changes in the design.
DELIVERY DATE: SEE OUR WEBSITE



DEVIATING ROAD NO.

Order no. **50580**

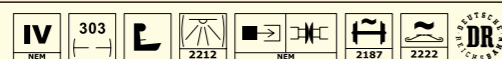

Model: Precise replica of the bogies; In-plane assembled windows; true-to epoch interior fittings; prepared for interior lighting; printed window frames; elastic rubber bulge; NEM-standard short coupling; replica of the air heating system in the car floor; alternator on bogie separately mounted; finest paintwork and printing



DEVIATING ROAD NO.

Order no. **50581**

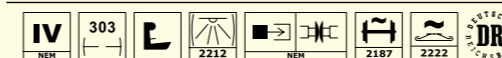

Passenger Coach Bmhe DR

Road no. 51 50 21-40 014-5 Halle Hbf

DELIVERY DATE: SEE OUR WEBSITE



DEVIATING ROAD NO.

Order no. **50582**

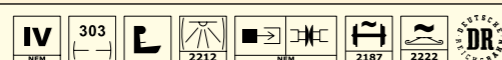

Passenger Coach Bmhe DR

Road no. 50 50 21-11 889-6
Magdeburg Hbf

DELIVERY DATE: SEE OUR WEBSITE



DEVIATING ROAD NO.

Order no. **50583**

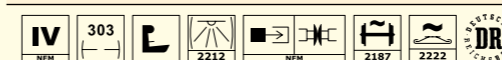

Passenger Coach Bmhe DR

Road no. 50 50 21-11 123-0 Stendal

DELIVERY DATE: SEE OUR WEBSITE



DEVIATING ROAD NO.

Order no. **50584**

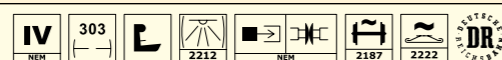

Passenger Coach Bmhe DR

Road no. 50 50 21-11 020-8
Schwerin Hbf

DELIVERY DATE: SEE OUR WEBSITE



DEVIATING ROAD NO.

Order no. **50585**

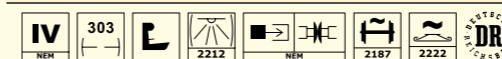

Passenger Coach Bmhe DR

Road no. 50 50 21-11 962-1 Eisenach

At first glance, the Bmhe seems like a copy of the DB Silberling, but it was in fact a new version of the Bghwe car, with many new components. This is especially evident in the unladen weight, which is fairly high at 39 tons and not compatible with the „world-class“ level so often aspired to in the DDR. The cars proved themselves in operation, and the passengers perceived them to be definite steps forward. In accordance with the requirements from the order, they were originally used almost exclusively in high-speed trains for national and international transport. They also achieved objectives in Czechoslovakia, Poland and West Germany. The cars that were delivered from 1982 onwards featured the new green and ivory colored paint for express cars.

DELIVERY DATE: SEE OUR WEBSITE





A RAILWAY GIANT FOR EXCEPTIONAL LOADS

HEAVY DUTY FREIGHT CAR SSt 125

TOTAL LENGTH
27,525 M

UNLOADED WEIGHT
97,2 T

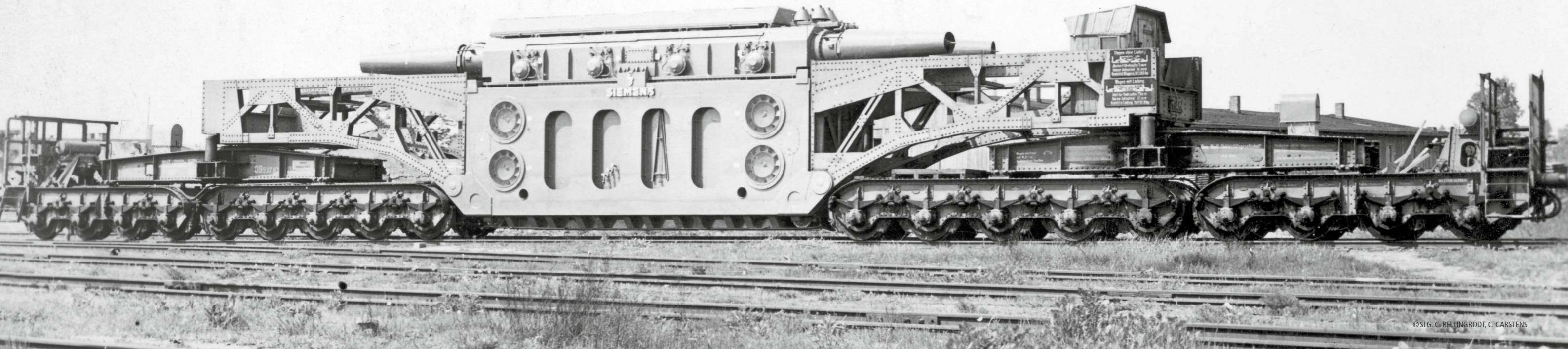

© SLG, C. BELLINGRODT, C. CARSTENS

Heavy Duty Freight Car SSt 125

Large and heavy loads require special means of transport or wagons. In 1928, Rheinisch Westfälische Elektrizitätswerk A.-G. Essen (RWE) placed an order with Maschinenfabrik Augsburg Nürnberg (MAN) for the construction of two new heavy-transport vehicles. This was the only way to transport the constantly growing transformers for the electricity substations. These were added to Sketch 125 in the directory of wagons for exceptional transports in the Deutsche Reichsbahn's rolling stock.

The maximum load capacity of the wagons was 168 tons, distributed over 18 axes. One four-axle and one five-axle bogie each carried a bridge, on which a support frame was mounted. The support frames featured the characteristic riveted truss construction. Unloaded, the two support frames were coupled with bolts, so that even when empty the heavy-transport wagons reached a length of 27.525 m over buffers. The wagon's dead weight was 97.2 t. For loading, the two halves were pulled apart and a self-supporting transformer or an 8.40 m-long lattice framework was suspended between the support frames.

As private vehicles ([P]-cars), the carriages were initially employed by the German Imperial Railway (Company) and later by the Federal Railway, and were initially home-based at Cologne Kendenich railway station operated by the K.B.E.

Two additional SSt 125s were also built by MAN in 1940 and belonged to PreussenElektra Hanover and Elektrowerke A.-G. Berlin. The latter remained with the National Railway in the Soviet zone after the war and later joined the East-German Deutsche Reichsbahn.

Due to the dimensions of the special cargo, which often exceeded the perimeter of the vehicle, the wagons were only permitted to travel at a maximum speed of 40 km/h when loaded as exceptional transports. And on narrow bridges, this was further reduced to walking speed while under observation. For this reason, such journeys were mainly carried out in the early morning or late evening. Unloaded, the wagons could be transported by regular goods

trains, albeit only at 65 km/h, which was the standard maximum speed for regular goods trains at that time. At DB, the maximum speed was increased to 80 km/h when roller bearings were installed.

The carriage 84 80 995 8 001-3, last based at Dortmund central railway station, was handed over by RWE Rhein-Ruhr Netzservice GmbH to Bahnwelt Darmstadt Kranichstein as a museum exhibit in 2011.

The BRAWA models show the epoch-relevant differences in construction details of the heavy duty freight cars and has many attached details. Numerous details such as e.g. replica of the truss support frame as multi-part construction ensure that the reproduction is true to original.



ORIGINAL

Year of construction	1928
Length	27,525 m
Axes	18
Weight (unloaded)	97,2 t
Maximum load	168 Tonnen



WWW.BRAWA.DE



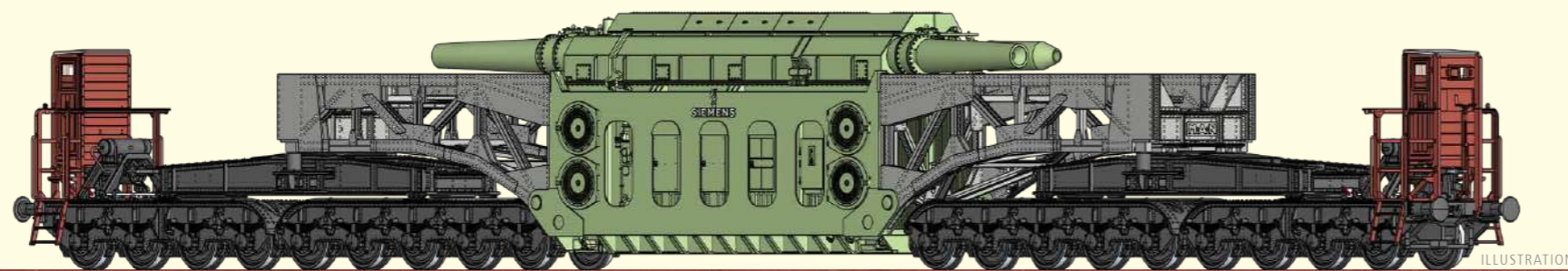

Order no. **50506** =

Order no. **50507** ~

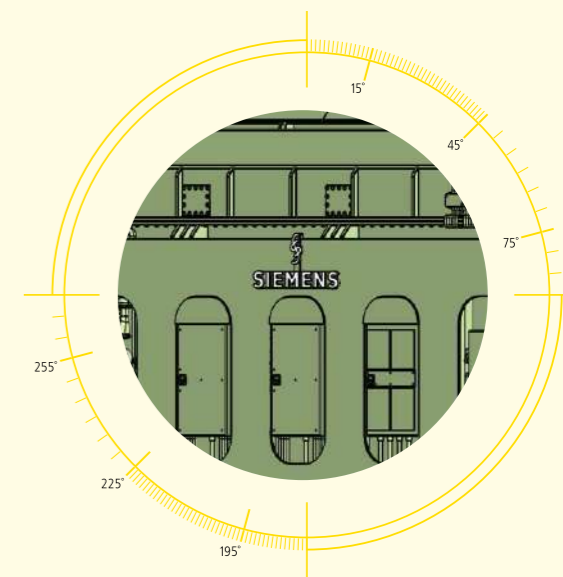
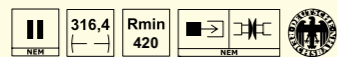

Heavy Duty Freight Car SSt 125 "RWE" DRG
Road no. 538 170 [P]

DELIVERY DATE: SEE OUR WEBSITE

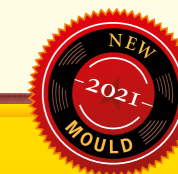
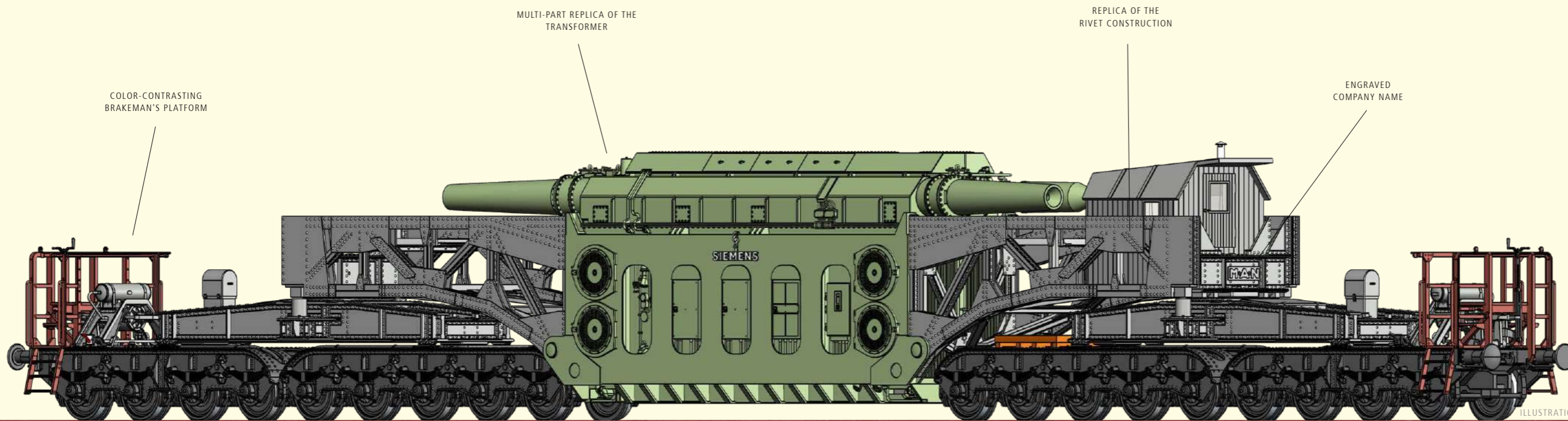

Heavy Duty Freight Car SSt 125 "RWE" DB
Road no. 537 629 [P]

Order no. **50508** =

Order no. **50509** ~



DELIVERY DATE: SEE OUR WEBSITE

- Epoch-relevant differences in construction
- Can be used either empty or loaded
- 18 Axes
- Replica of the truss support frame as multi-part construction

- Four bogies
- NEM-standard short-coupling
- The trafo swings out very strongly in curves
- Navigable minimum radius: we recommend the use on R=420

- Extra mounted steps and handrails
- Metal wheels
- Extra mounted brake system
- Finely detailed chassis



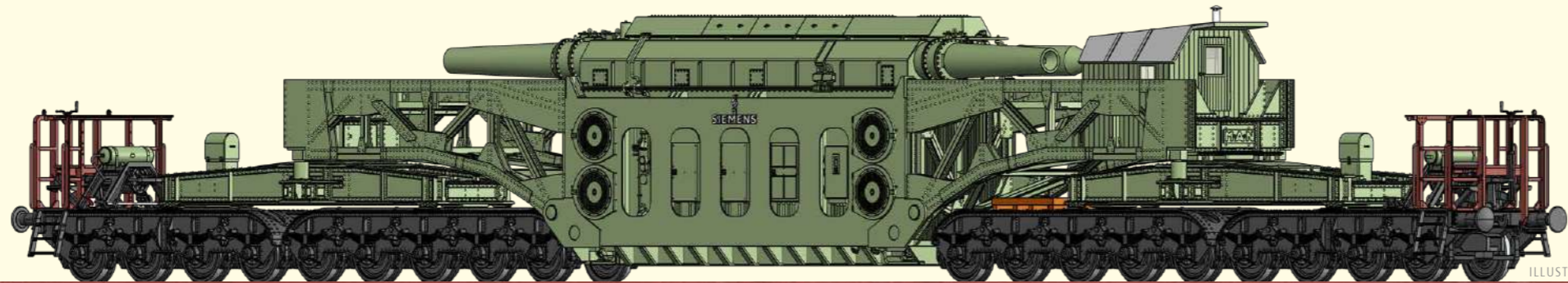

ILLUSTRATION



Order no. **50510** =

Order no. **50511** ~

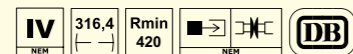

Heavy Duty Freight Car Uaai 672.9
"RWE" DB
Road no. 84 80 096 0 258-4 [P]

DELIVERY DATE: SEE OUR WEBSITE

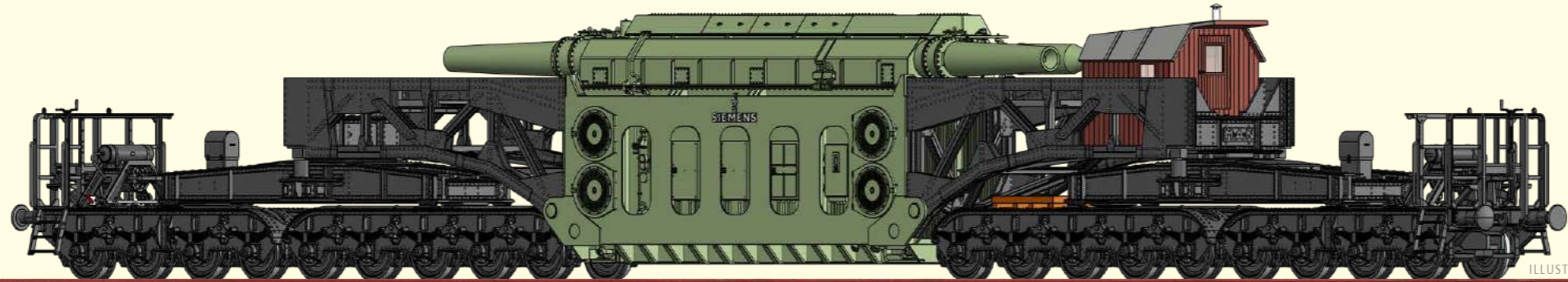
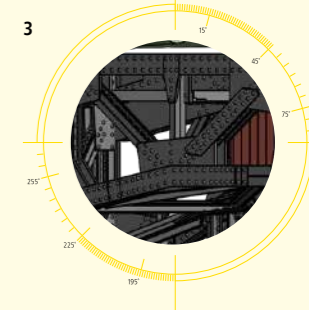
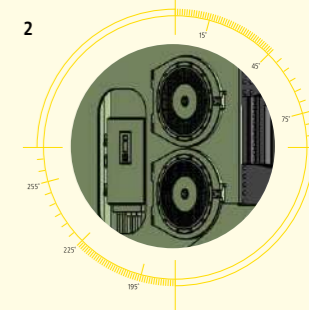
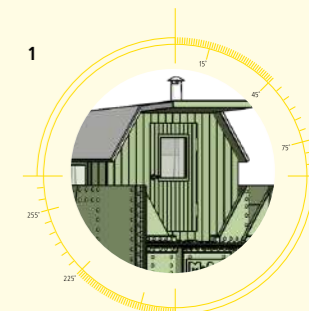

ILLUSTRATION



Order no. **50512** =

Order no. **50513** ~

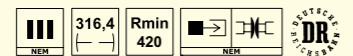

Heavy Duty Freight Car SSt DR
Road no. 66-36-00

DELIVERY DATE: SEE OUR WEBSITE

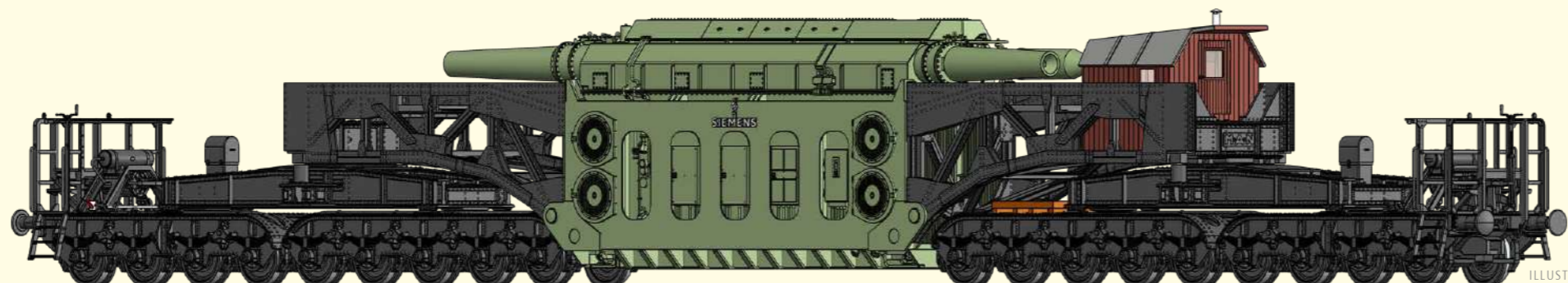

ILLUSTRATION



Order no. **50514** =

Order no. **50515** ~

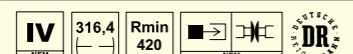

Heavy Duty Freight Car Uaai [9950] DR
Road no. 82 50 995 8401-3

DELIVERY DATE: SEE OUR WEBSITE



Stake Car Remms 665 DB AG
Road no. 31 80 3948 007-0



DEVIATING ROAD NO.

Order no. **47119** 161,4

DELIVERY DATE: SEE OUR WEBSITE

Stake Car Remms SNCF
Road no. 31 87 398 7 645-2



Order no. **47120** 161,4

DELIVERY DATE: SEE OUR WEBSITE

Refrigerator Car Ipi "Transtermos Kühlverkehr" DSB
Road no. 25 401

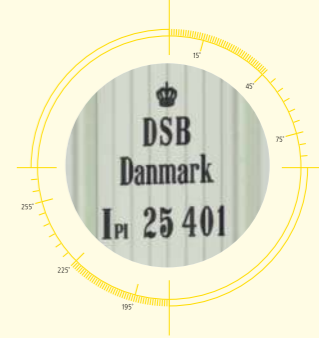

Order no. **47614** 139,1

DELIVERY DATE: SEE OUR WEBSITE

Stake Car Rgmms FS
Road no. 31 83 396 8 879-4



Order no. **47121** 161,4

DELIVERY DATE: SEE OUR WEBSITE

Stake Car Rrym 60 DR
Road no. 60-22-12



Order no. **47577** 182,7

DELIVERY DATE: SEE OUR WEBSITE

Refrigerator Car Tnoms 35 DB
Road no. 301 007



Order no. **47625** 139,1

DELIVERY DATE: SEE OUR WEBSITE

Refrigerator Car Ibdlps383 "Interfrigo" DB
Road no. 11 80 802 4 728-1



Order no. **47617** 139,1

DELIVERY DATE: SEE OUR WEBSITE

Stake Car Samm-u 4818 "VEB Kühlautomaten" DR
Road no. 31-50-482 0433-5



Order no. **47575** 182,7

DELIVERY DATE: SEE OUR WEBSITE

Stake Car Samm-u 4818 DR
Road no. 31-50-482 0208-1



Order no. **47576** 182,7

DELIVERY DATE: SEE OUR WEBSITE

Refrigerator Car Ibdlps383 "Pschorr" DB
Road no. 21 80 805 0 016-6 [P]



Order no. **47618** 139,1

DELIVERY DATE: SEE OUR WEBSITE

Refrigerator Car "Kulmbacher Mönchshof-Bräu" DB
Road no. 21 80 080 0 769-0 [P]



Order no. **47619** 139,1

DELIVERY DATE: SEE OUR WEBSITE

Maintenance Car X 35 DB
Road no. 463 648



Order no. **49360** 104,6

DELIVERY DATE: SEE OUR WEBSITE

Maintenance Car Xr 35 DB
Road no. 465 130



Order no. **49361** 104,6

DELIVERY DATE: SEE OUR WEBSITE

Refrigerator Car Ibs "Paulaner" DB
Road no. 23 80 805 0 031-3 [P]



Order no. **47622** 139,1

DELIVERY DATE: SEE OUR WEBSITE

Refrigerator Car Ibdlps 383 "INTERFRIGO Gesundheit und Fisch Cuxhaven" DB
Road no. 11 80 802 4 884-2



Order no. **47628** 139,1

DELIVERY DATE: SEE OUR WEBSITE



Tank Car ZZ [P] "Leuna" DR
Road no. 51-72-05 [P]



Order no. **49606** III 142,5 2188 DR

AVAILABLE

Tank Car ZZ [P] "VEB Synthesewerk Schwarzheide" DR
Road no. 51-71-29 [P]



Order no. **49610** III 142,5 2188 DR

DELIVERY DATE: SEE OUR WEBSITE

Covered Freight Car K2 SBB
Road no. 35 233



Order no. **47886** II 95,8 2183 SBB CFF

DELIVERY DATE: SEE OUR WEBSITE

Covered Freight Car K2 MThB / SP
Road no. 874



Order no. **47888** III 95,8 2183

DELIVERY DATE: SEE OUR WEBSITE

Tank Car ZZ [P] "VTG" DB
Road no. 591 449 [P]



Order no. **49613** III 142,5 2188 DB

DELIVERY DATE: SEE OUR WEBSITE

Tank Car ZZ [P] "VTG" DB
Road no. 33 80 774 0 319-8 [P]



Order no. **49609** IV 142,5 2188 DB

DELIVERY DATE: SEE OUR WEBSITE

Covered Freight Car K2 BLS
Road no. 3077



Order no. **47881** III 95,8 2187 BLS

DELIVERY DATE: SEE OUR WEBSITE

Covered Freight Car Gklm "Henniez Mineralwasser" SBB
Road no. 20 85 114 5 018-0



Order no. **47882** III 95,8 2187

DELIVERY DATE: SEE OUR WEBSITE

Tank Car Uia "KVG"
Road no. 33 80 795 6 372-6



Order no. **50566** V 187,5 2187

DELIVERY DATE: SEE OUR WEBSITE

Tank Car Zas "ERMEWA"
Road no. 33 80 795 6 860-0



Order no. **50563** VI 187,5 2187

DELIVERY DATE: SEE OUR WEBSITE

Covered Freight Car Gklm "Appenzeller" SBB
Road no. 20 85 111 8 514-1



Order no. **47884** IV 95,8 2187

DELIVERY DATE: SEE OUR WEBSITE

Covered Freight Car Gklm "Aproz" SBB
Road no. 20 85 111 8 760-0



Order no. **47885** IV 95,8 2187

DELIVERY DATE: SEE OUR WEBSITE

Tank Car Zas "ERMEWA"
Road no. 33 80 795 7 196-8



Order no. **50565** VI 187,5 2187

DELIVERY DATE: SEE OUR WEBSITE

Tank Car Zas "VTG"
Road no. 33 80 795 6 787-5



Order no. **50567** VI 187,5 2187 VTG

DELIVERY DATE: SEE OUR WEBSITE

Covered Freight Car G "Freiherrlich von Tuchersche Brauerei Nürnberg" K.Bay.Sts.B.
Road no. 80 169



Order no. **48034** I 97,1 2183

DELIVERY DATE: SEE OUR WEBSITE

Covered Freight Car Gw "MAN" DRG
Road no. 2671



Order no. **48036** II 97,1 2183

AVAILABLE





FOR BULK CARGO AND PART LOADS. AND LOVERS OF DETAIL.

LIDDED FREIGHT CAR K25



© SLG. C. CARSTENS

For the transport of moisture-sensitive goods, such as lime, the railways introduced so-called "Lidded Freight Cars" in various designs from a very early stage. In the second half of the 1920s, the development of this car type resulted in the K Elberfeld 80 001 ff., which met the requirements for the "Austauschbauart" (a design based on standardised components) that were valid at that time, and was standardised accordingly. The freight car had a length of 8.1 m (without handbrake) and 8.8 m (with handbrake), as well as the short 4 m wheel base that was typical for this period and had a maximum load of 17.5 t. In order to withstand this weight, the side panels and hinge lid were strengthened with prominent crossed beads.

While the original paint was RAL 8012, with the undercarriage and offset fittings in RAL 9005, this quickly changed to light grey streaks when loaded with lime. The 991 freight cars delivered by 1933 were also the last cars to be built in series. Although the lidded freight cars could be loaded mechanically, they could only be unloaded manually. As a result, the development of self-unloading cars for the transport of similar goods was already underway in the days of the Reichsbahn, and there were no significant new developments after the K25. Nevertheless, the vehicles classified by the Bundesbahn (Federal Railway) as K25 remained in regular service until the end of the 1960s and, in isolated cases, for even longer as service vehicles.

- Axle holder made of metal
- Extra brake systems
- With brakeman's cab and platform
- Fine engravings and rivets
- Extra mounted signal holder

Lidded Freight Car K Elberfeld DRG
Road no. 80 007



ILLUSTRATION

Order no. **50538**

DELIVERY DATE: SEE OUR WEBSITE

Lidded Freight Car K Wuppertal DRG
Road no. 80 913



ILLUSTRATION

Order no. **50539**

DELIVERY DATE: SEE OUR WEBSITE

Lidded Freight Car K 25 DB
Road no. 340 418



ILLUSTRATION

Order no. **50540**

DELIVERY DATE: SEE OUR WEBSITE

Lidded Freight Car K 25 DB
Road no. 340 663



ILLUSTRATION

Order no. **50542**

DELIVERY DATE: SEE OUR WEBSITE

Lidded Freight Car Uk-v 25 DB
Road no. 344 010



ILLUSTRATION

Order no. **50544**

DELIVERY DATE: SEE OUR WEBSITE

Lidded Freight Car K DR
Road no. 21-84-06



ILLUSTRATION

Order no. **50546**

DELIVERY DATE: SEE OUR WEBSITE

Lidded Freight Car K 25 DB
Road no. 340 827



ILLUSTRATION

Order no. **50541**

DELIVERY DATE: SEE OUR WEBSITE

Lidded Freight Car Uk-v 25 DB
Road no. 342 707



ILLUSTRATION

Order no. **50543**

DELIVERY DATE: SEE OUR WEBSITE

Lidded Freight Car K DR
Road no. 21-83-49



ILLUSTRATION

Order no. **50545**

DELIVERY DATE: SEE OUR WEBSITE

Lidded Freight Car K ÖBB
Road no. 834 507



ILLUSTRATION

Order no. **50547**

DELIVERY DATE: SEE OUR WEBSITE



Covered Freight Car G10 "Elefanten Schuhe" DB
Road no. 141 625

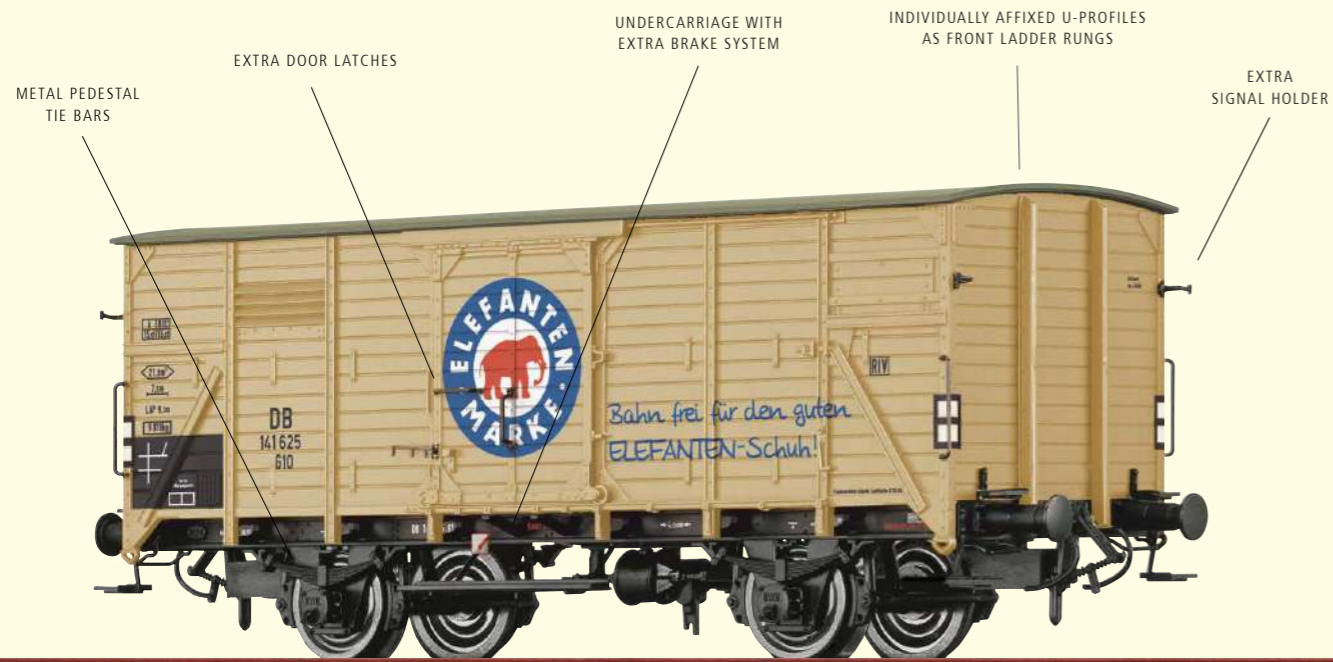

Order no. **49818**

DELIVERY DATE: SEE OUR WEBSITE

Covered Freight Car G DRG
Road no. 72 684



Order no. **49821**

DELIVERY DATE: SEE OUR WEBSITE

Covered Freight Car G "Mignon" DRG
Road no. 45 672



Order no. **49828**

DELIVERY DATE: SEE OUR WEBSITE

Covered Freight Car Gkh "VEB Schlachtwagen" DR
Road no. 56-01-73 [P]



Order no. **49816**

DELIVERY DATE: SEE OUR WEBSITE

Covered Freight Car G DR
Road no. 05-78-50



Order no. **49823**

DELIVERY DATE: SEE OUR WEBSITE

Covered Freight Car Nm BadStB
Road no. 18 219



Order no. **49852**

DELIVERY DATE: SEE OUR WEBSITE

Covered Freight Car Gm K.Bay.Sts.B.
Road no. 30 521



Order no. **49825**

DELIVERY DATE: SEE OUR WEBSITE

Covered Freight Car G10 "Glänzer (Erdal)" DB
Road no. 123 453 [P]



Order no. **49763**

AVAILABLE

Covered Freight Car G DB
Road no. 52 953



Order no. **49822**

DELIVERY DATE: SEE OUR WEBSITE

Covered Freight Car Gm K.W.St.E.
Road no. 29 500



Order no. **49824**

DELIVERY DATE: SEE OUR WEBSITE

Covered Freight Car "Elefantenbräu" DRG
Road no. 600009 [P]



Order no. **49811**

DELIVERY DATE: SEE OUR WEBSITE

Covered Freight Car G10 "IMI" DB
Road no. 146 736



Order no. **49827**

DELIVERY DATE: SEE OUR WEBSITE

Covered Freight Car Gklm "Tetraethylblei" DR
Road no. 21 50 010 0527-5



Order no. **49072**

DELIVERY DATE: SEE OUR WEBSITE



Covered Freight Car K3 SBB
Road no. 134127



Order no. **49838**

DELIVERY DATE: SEE OUR WEBSITE

Covered Freight Car Go "Ceskoslovenska Komise Cukerni v Praze" CSD
Road no. 3.01001 [P]



Order no. **49839**

DELIVERY DATE: SEE OUR WEBSITE

Covered Freight Car Gh "Moser-Roth Schokolade" DRG
Road no. 41 402



Order no. **50350**

AVAILABLE

Covered Freight Car Gh 03 "Breisgau Milch" DB
Road no. 103 582



Order no. **48669**

AVAILABLE

Covered Freight Car G "Gösser" ÖBB
Road no. 560 003 [P]



Order no. **49849**

DELIVERY DATE: SEE OUR WEBSITE

Covered Freight Car G "Wieselburger" ÖBB
Road no. 560 010 [P]



Order no. **49850**

DELIVERY DATE: SEE OUR WEBSITE

Open Freight Car Omm 52 DB
Road no. 896 549



Order no. **48632**

DELIVERY DATE: SEE OUR WEBSITE

Open Freight Car E 037 DB
Road no. 01 80 504 1 057-2



Order no. **48633**

DELIVERY DATE: SEE OUR WEBSITE

Covered Freight Car G10 "Niemetz Schwedenbomben" ÖBB
Road no. 165 542



Order no. **49829**

DELIVERY DATE: SEE OUR WEBSITE

PERFECTLY EQUIPPED

You can now find lamps, cable railways, a variety of equipment details and a wide range of electrical accessories for HO and N in the BRAWA accessories catalogue or at www.brawa.de.

Covered Freight Car Kmmks 51 DB
Road no. 362 914



Order no. **48634**

DELIVERY DATE: SEE OUR WEBSITE

Covered Freight Car Tms 851 DB
Road no. 01 80 575 8 884-2



Order no. **48635**

DELIVERY DATE: SEE OUR WEBSITE

Covered Freight Car Hlf "Kronenbourg - Biere d'Alsace" SNCF
Road no. 505026 [P]



Order no. **49847**

DELIVERY DATE: SEE OUR WEBSITE

Covered Freight Car Hlf "Bières Mutzig" SNCF
Road no. 505131 [P]



Order no. **49848**

DELIVERY DATE: SEE OUR WEBSITE

Open Freight Car Omu (O) DR
Road no. 21 50 558 6864-4



Order no. **48444**

AVAILABLE

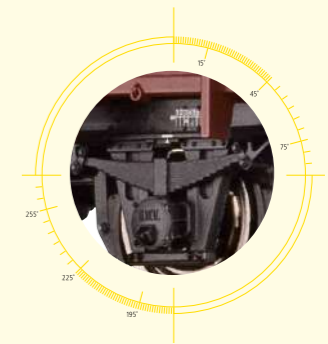

DEVIATING ROAD NO.





THIS DETAILS SHOULD STIR THINGS UP QUITE A BIT

CONTAINER CAR KDS 54 / 56



Container Car Kds 54 DB
Road no. 359 490



Together with Waggon Union, Deutsche Bundesbahn (DB) developed a new twin-axle container wagon for powdered goods with two standing containers. Westwagon delivered the first 10 wagons to DB for testing in 1953. As they still had a Hik-brake system, these were designated as Kd 54. In addition, they featured a double-hook drive, as did the 150 wagons that followed from Talbot and Westwagon. Since this led to problems associated with the unique undercarriage construction, all subsequent deliveries were equipped with running gear with single hooks. After only 50 carriages, the container volume was increased to 2 x 13.5 m³. These carriages proved themselves with aplomb – by 1965, a total of 1,232 Kds 54 had been purchased. For lighter powdered goods, 1293 Kds 56 units with 2 x 17.5 m³ containers were built in parallel. The extra volume of 4 m³ resulted in larger containers and wagons that were correspondingly taller. To secure the parked wagons, some of the Kds 54/56 were equipped with a handbrake that could be operated from the platform. Unlike DB's other newly constructed freight cars, whose hand-brake platforms were bolted to the undercarriage, they were directly integrated on these vehicles. In this way, the length over buffers of wagons equipped in such a manner remained unchanged and only the dead weight was increased. Compared with the

total number of more than 2,500 wagons built, Kds 54/56 wagons equipped with a handbrake were comparatively rare. With the introduction of the 12-digit UIC number, the Kds 54 wagons were redesignated as Ucs 908, and the Kds 56 as Ucs 909. For many years, both types formed the backbone of the Deutsche Bahn's powder wagon stock. The first reductions in stock occurred in 1967 when 86 wagons were sold. Further sales to EVA and VTG followed in later years. In the 1990s, DB AG relocated most of its wagons to its subsidiary MEG. The remaining DB AG wagons were mostly rented out or used, for example, for the internal transport of traction sand for tractive units. Other than cement, the wagons have also been used to transport several other powdered goods over the years. These include: stone dust, silica sand, kieserite, gypsum, sodium sulphate, Thomas sulphate, sugar, salt and aluminium hydroxide. The wagons were then generally home-based at a railway station.

Order no. **50518**

DELIVERY DATE: SEE OUR WEBSITE

- Variants with and without brakemen's platform
- Separately mounted container cover and valves
- Brake shoes in wheel plane
- Extra mounted steps
- Separately mounted axle brake rod
- Extra mounted brake system
- NEM-standard close coupling
- Fine painwork and printing



Container Car Ucs 908 "Quarzwerke" DB
Road no. 21 80 910 5 380-9



Order no. **50529**

DELIVERY DATE: SEE OUR WEBSITE

Container Car Ucs 908 "Villeroy & Boch" DB
Road no. 21 80 910 5 897-2



Order no. **50532**

DELIVERY DATE: SEE OUR WEBSITE

Container Car Ucs 908 "Dyckerhoff" DB
Road no. 21 80 910 5 534-1



Order no. **50536**

DELIVERY DATE: SEE OUR WEBSITE

Container Car Ucs 908 DB
Road no. 21 80 910 5 151-4



Order no. **50522**

DELIVERY DATE: SEE OUR WEBSITE

Container Car Ucs 908 "Dyckerhoff" DB
Road no. 21 80 910 5 034-2



Order no. **50535**

DELIVERY DATE: SEE OUR WEBSITE

Container Car Ucs 908 DB AG
Road no. 21 80 910 6 211-5



Order no. **50526**

DELIVERY DATE: SEE OUR WEBSITE

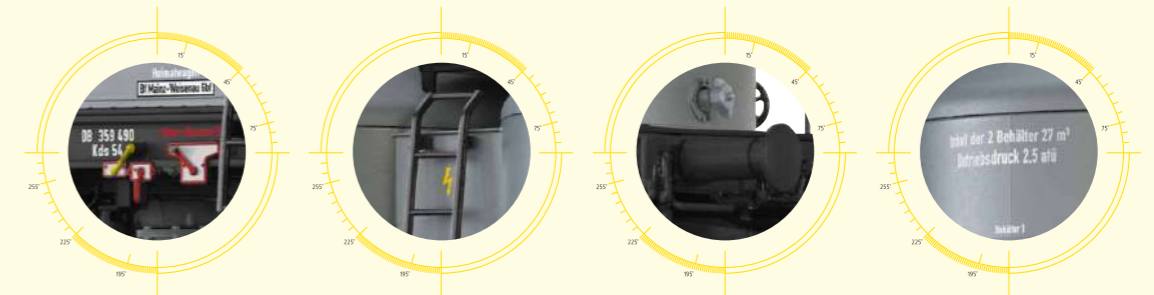

Container Car Ucs 909 "Brandt" DB
Road no. 41 80 910 8 459-4



Order no. **50530**

DELIVERY DATE: SEE OUR WEBSITE

Container Car Ucs 909 "EVA" DB
Road no. 43 80 910 4 480-2 [P]



Order no. **50534**

DELIVERY DATE: SEE OUR WEBSITE

Container Car Kds 56 DB
Road no. 359 598



Order no. **50520**

DELIVERY DATE: SEE OUR WEBSITE

Container Car Ucs 909 DB
Road no. 41 80 910 8 149-1



Order no. **50524**

DELIVERY DATE: SEE OUR WEBSITE

Container Car Ucs 909 DB AG
Road no. 41 80 910 8 044-4



Order no. **50527**

DELIVERY DATE: SEE OUR WEBSITE

Container Car Ucs 909 "Brandt" DB AG
Road no. 41 80 910 8 008-9



Order no. **50531**

DELIVERY DATE: SEE OUR WEBSITE

Container Car Ucs 909 "Franken Zucker" DB
Road no. 41 80 910 8 320-8



Order no. **50533**

DELIVERY DATE: SEE OUR WEBSITE

Container Car Ucs 909 "Degussa" DB
Road no. 45 80 910 8 591-0



Order no. **50537**

DELIVERY DATE: SEE OUR WEBSITE





DEVIATING ROAD NO.

Open Freight Car Eds-u Ommstu "Rekord Briketts" DR
Road no. 21 50 550 1282-1

DELIVERY DATE: SEE OUR WEBSITE

Order no. **49536**

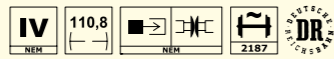

Model: Wheelsets in toe bearing; bogie with three-point support; originally reproduced, three-dimensional frame body; individually mounted axle box cover; brake blocks in wheel plane; extra mounted handrails and steps; extra mounted axle brake frame; extra braking system; NEM close coupling



Order no. **50403**

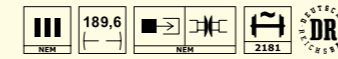

Model: Wheelsets in toe bearing; bogie with three-point support; originally reproduced, three-dimensional frame body; individually mounted axle box cover; brake blocks in wheel plane; extra mounted handrails and steps; extra mounted axle brake frame; extra braking system; perforated coach body supports

Covered Freight Car GGhzs DR
Road no. 15-58-17

The result of developments during the war produced different types of four-axle boxcars which were then produced in large quantities. These developments produced the GGhrs model from 1966 onwards. These cars were then later designated as Gagmrs-v and then as Gags type code number 1992. The definitive form of the four-axle boxcars of the Deutsche Reichsbahn had finally been identified thanks to this style, which is why the cars were produced in large quantities. The vehicles had a loading capacity of 57 t. The body was made up of sheet metal which was welded together and the floor was made out of wood. After the German reunification, these cars were no longer in the communal freight car fleet, but some of them continued to be used as private cars.

DELIVERY DATE: SEE OUR WEBSITE



Open Freight Car Fcs Wiebe
Road no. 27 80 6452 689-2

DELIVERY DATE: SEE OUR WEBSITE

Order no. **49534**

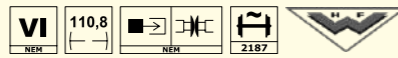

Order no. **50405**

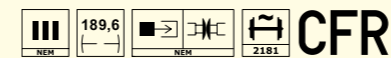

Covered Freight Car GvASFW CFR
Road no. 183131

DELIVERY DATE: SEE OUR WEBSITE

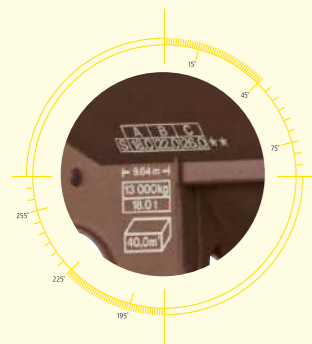

Covered Freight Car Tds "Austria Glas Recycling GmbH" ÖBB
Road no. 21 81 0737 221-9

DELIVERY DATE: SEE OUR WEBSITE

Order no. **49537**



Order no. **50404**

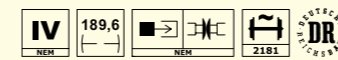

Covered Freight Car GGh DR
Road no. 01 50 199 2101-2

DELIVERY DATE: SEE OUR WEBSITE



Covered Freight Car Glt "Eisenacher Motorenwerke" DRG
Road no. 81 785

EXTRA MOUNTED BRAKE SYSTEM
AND BRAKE SWITCH, SPRINGS,
WHEEL BEARING AND STEPS

FINE ENGRAVINGS
AND RIVETS

AXLE BEARINGS MADE FROM
STAMPED SHEET METAL



Order no. **50463**

DELIVERY DATE: SEE OUR WEBSITE

Covered Freight Car KKds 55 DB
Road no. 358 008

TRUE-TO-ORIGINAL REPLICA
OF THE CAR BOTTOM

SEPARATELY MOUNTED CONTAINER
COVER AND VALVES

SHORT COUPLING
KINEMATICS



Order no. **50306**

DELIVERY DATE: SEE OUR WEBSITE

Covered Freight Car Glr 22 DR
Road no. 12-95-04

Covered Freight Car Glt 23 "Goggo" DB
Road no. 195 550



Order no. **50456**

DELIVERY DATE: SEE OUR WEBSITE

Order no. **50462**

DELIVERY DATE: SEE OUR WEBSITE

Covered Freight Car KKds 55 DB
Road no. 358 011

Covered Freight Car Uacs 946 DB
Road no. 31 80 930 5 000-9



Order no. **50307**

DELIVERY DATE: SEE OUR WEBSITE

Order no. **50309**

DELIVERY DATE: SEE OUR WEBSITE

Covered Freight Car Glt "Steyr Puch" ÖBB
Road no. 213 626



Order no. **50461**

DELIVERY DATE: SEE OUR WEBSITE



**AUTOMATICALLY RECEIVE
NEWS FROM BRAWA**

Simply subscribe to the free BRAWA
newsletter at www.brawa.de and you'll
always know what's currently happening.

**Covered Freight Car Uacs 946 "Saarfeldspatwerke Ruppert
GmbH & Co. KG" DB**
Road no. 33 80 930 5 130-2 [P]



Order no. **50308**

DELIVERY DATE: SEE OUR WEBSITE

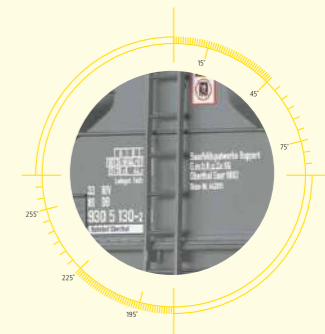

Covered Freight Car Gmmehs 56 DB
Road no. 292 382



Order no. **50101** III 127,3 2187 DB

DELIVERY DATE: SEE OUR WEBSITE

Covered Freight Car K4 "EUROP" SBB
Road no. 49662



Order no. **50120** III 121,6 2187 SBB CFF

DELIVERY DATE: SEE OUR WEBSITE

Covered Freight Car Kf "EUROP" SNCF
Road no. 340 207



Order no. **50111** III 127,3 2187 SNCF

DELIVERY DATE: SEE OUR WEBSITE

Covered Freight Car Gs FS
Road no. 1164756



Order no. **50114** III 121,6 2187 FS Italia

DELIVERY DATE: SEE OUR WEBSITE

Covered Freight Car iGs 212 "EUROP" DB
Road no. 01 80 125 3 829-6



Order no. **50103** IV 121,6 2187 DB

DELIVERY DATE: SEE OUR WEBSITE

Covered Freight Car Gs "EUROP" DSB
Road no. 01 86 123 0 005-5



Order no. **50124** IV 121,6 2187 DSB

DELIVERY DATE: SEE OUR WEBSITE

Covered Freight Car Gs "EUROP" CFL
Road no. 01 82 120 1 200-1



Order no. **50113** IV 121,6 2187 CFL

DELIVERY DATE: SEE OUR WEBSITE

Covered Freight Car Gs "EUROP" SBB
Road no. 01 85 120 1 433-5



Order no. **50122** V 121,6 2187

DELIVERY DATE: SEE OUR WEBSITE

Covered Freight Car Gs 213 "EUROP" DB
Road no. 01 80 123 7 003-9



Order no. **50106** V 121,6 2187 DB

DELIVERY DATE: SEE OUR WEBSITE

Covered Freight Car Gs "EUROP" NS
Road no. 01 84 127 2 770-5



Order no. **50118** V 121,6 2187

DELIVERY DATE: SEE OUR WEBSITE

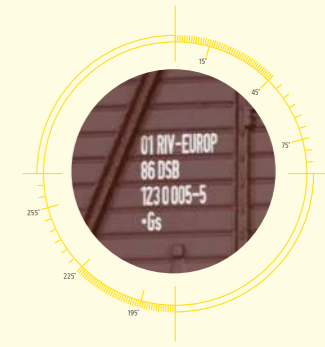

Refrigerator Car UIC St 1 2 "INTERFRIGO" DB
Road no. 524 068 [P]



Order no. **50517** III 135 2181 DB

DELIVERY DATE: SEE OUR WEBSITE

Refrigerator Car IF "EVIAN & BADOIT" SNCF
Road no. 506014[P]



Order no. **48348** III 135 2181 SNCF

DELIVERY DATE: SEE OUR WEBSITE

Covered Freight Car Gms 30 "Maggi" DB
Road no. 228 013



PICTURE SHOWS GAUGE 0-MODEL

Order no. **47945** III 104,6 2187 DB

DELIVERY DATE: SEE OUR WEBSITE

Covered Freight Car Twrso "Bananen" DR
Road no. 17-41-15



Order no. **47946** III 104,6 2187 DR

DELIVERY DATE: SEE OUR WEBSITE

Refrigerator Car Ibces "INTERFRIGO" DB
Road no. 11 80 082 5 099-5 [P]



Order no. **48345** IV 135 2181 DB

AVAILABLE

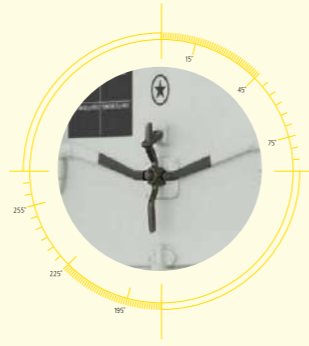

Covered Freight Car Gms 30 DB
Road no. 227 598



Order no. **47996** III 104,6 2187 DB

DELIVERY DATE: SEE OUR WEBSITE

Covered Freight Car Gms 30 "Frico" NS
Road no. 552 406



Order no. **47994** III 112,6 2187 NS

DELIVERY DATE: SEE OUR WEBSITE

Tank Car ZZd [P] "Chem. Werke Hüls Gesellschaft m.b.H. Marl" DRG
Road no. 509 237 [P]



Order no. **50561** II 155 2187

DELIVERY DATE: SEE OUR WEBSITE

Tank Car ZZd [P] "HOECHST AG." DB
Road no. 516 302 [P]



Order no. **50562** III 155 2187 DB

DELIVERY DATE: SEE OUR WEBSITE

Covered Freight Car Gkklms ÖBB
Road no. 01 81 138 5 411-3



Order no. **47991** IV 104,6 2187 ÖBB

DELIVERY DATE: SEE OUR WEBSITE

Covered Freight Car (Mosw) Mso DR
Road no. 27 50 205 6315-9



Order no. **47993** IV 112,6 2187 DR

DELIVERY DATE: SEE OUR WEBSITE

Covered Freight Car Glmms DR
Road no. 21 50 150 0054-4



DEVIATING ROAD NO.

Order no. **47909** IV 161,1 2187 DR

AVAILABLE

Covered Freight Car Gos-uv 253 "Peugeot Talbot" DB
Road no. 21 80 141 4 427-1



DEVIATING ROAD NO.

Order no. **47295** IV 143,7 2187 DB

DELIVERY DATE: SEE OUR WEBSITE

MODEL RAILWAY HISTORY OF SPECIAL KIND



At the BRAWA Museum you will find an extensive selection of locomotives, railcars, passenger coaches and freight cars (gauge HO, N, TT, O and IIm), that are no longer available ex works.

We wish you much fun while discovering our "historic" models.

WWW.BRAWA.DE/FANWELT/ONLINE-MUSEUM



Container Car Sffggmrss FS
Road no. 31 83 4909 817-4

The „megafret“ container car was developed for the transportation of high cube containers. These containers have corner heights of 2.80 and sometimes 3.20 m. Transfesa's slide-wall containers are 45 feet long. The „megafret“ wagons are loaded with standard containers and can hold up to four 20-foot containers. The container cars can travel at speeds of up to 140 km/h and the unit has a load capacity of 87 t. The wagons are used on all European railways, including the UK.
DELIVERY DATE: SEE OUR WEBSITE



Order no. **48103**



Model: True-to-original connection drawbar; brake pipes assembled with steel profiles; multi-part brake system (visible from above); individually mounted aggregates at the chassis; handles and steps in lower-density material; conduction in steel wire; detailed bogie; precise printing; many extra mounted parts; open frame

In contrast to the picture, article 48103 is loaded with two 40"-containers. Not with four 20"-containers.

Container Car Sffggmrss AAE
Road no. 33 68 4909 883-3

The Ahaus-Altstätter-Eisenbahn AAE, a private railway near the Dutch border has recently made a name for itself as a car hire company. One of AAE'S major areas of concentration is the hiring of cars for container traffic. In addition to the 4 and 6-axle cars, it also has 8-axle low-platform units "megafret" on stock. The "megafret" cars are 8-axle units comprising two 4-axle cars which are tightly coupled and which cannot be separated when in operation. They have a low loading surface of 825 mm above the upper rail level, so that even the new "High-cube" containers can be transported.
DELIVERY DATE: SEE OUR WEBSITE



Order no. **48104**



In contrast to the picture, article 48104 is loaded with two 40"-containers. Not with four 20"-containers.

225°

195°

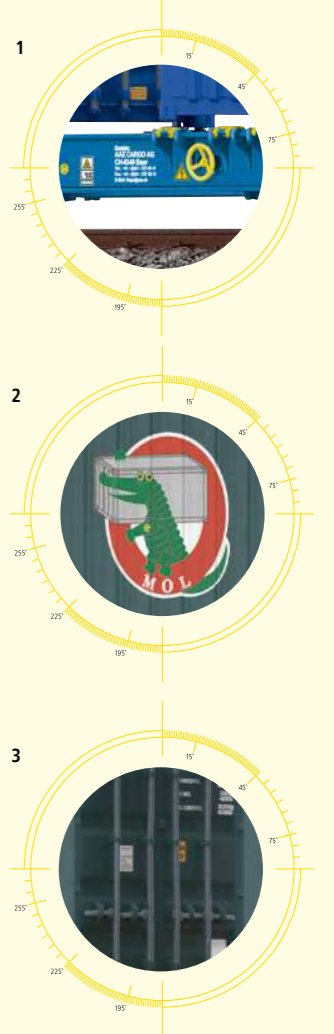

- 1_Originally reproduced, three-dimensional frame body
- 2_With two containers
- 3_Many extra mounted parts

(Photos show order no. 48104)





ZUBEHÖR

Electrical coupling 4-pin for NEM standard shaft
Set of 4



Order no. **93716**

DELIVERY DATE: SEE OUR WEBSITE

Description: Symmetrical arrangement of contacts; same coupling for both sides of a locomotive or wagon; mechanical locking; gold-plated contact pins; resilience to 1A at 24V, with 4 different colored wires with a length of 250 mm

Electrical coupling 6-pin for NEM standard shaft
Set of 4



Order no. **93717**

DELIVERY DATE: SEE OUR WEBSITE

Description: Asymmetrical arrangement of contacts; different couplings for each side of a locomotive or wagon; mechanical locking; gold-plated contact pins; resilience to 1A at 24V, with 6 different colored wires with a length of 250 mm

Tool for coupling/decoupling
For electrical couplings



Order no. **93718**

DELIVERY DATE: SEE OUR WEBSITE

Description: Tool for coupling and decoupling locomotives and wagons with an electric coupling; suitable for the 4-pin and 6-pin electric coupling; prevents the coupling to the track during coupling; lifts the hooks of the mechanical lock when coupling

You
Tube



★

Visit our Youtube Channel and discover the digital functions of the BRAWA Twindexx Vario® IC2 and more information about the electrical coupling!



WWW.BRAWA.DE



PERFECTLY EQUIPPED

You can now find lamps, cable railways, a variety of equipment details and a wide range of electrical accessories for HO and N in the BRAWA accessories catalogue or at www.brawa.de.



HO

HO

SMALL GAUGE BIG DIESEL DETAILS

DIESEL LOCOMOTIVE BR 132

Following the models 130 (maximum speed 140 km/h) and 131 (100 km/h), the DB put the 132 model (120 km/h) into service after 1974 with the electric heating system. Thanks to its configuration, the DR had found its optimum machine. This is why the DR acquired 709

locomotives from the factory in Woroschilowgrad. After a few initial teething problems, the technical service finally had a reliable and multifunctional machine.

- With Next18 interface
- Rear signals
- Illuminated driver's cab
- True to original sound
- 5-pole motor
- All axles driven
- True-to-original speed
- Standard shaft to NEM 355
- Front light changes according to direction of travel
- Reproduction of cooling van
- Finely engraved details

ORIGINAL

Year of construction
1973

Length
20,82 m

Velocity
120 km/h

Weight
122 t



DEVIATING ROAD NO. / HO-MODEL



Order no.
61032

Order no.
61033

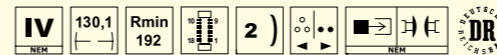

Diesel Locomotive 132 DR
See our website for road no.

DELIVERY DATE: SEE OUR WEBSITE

DEVIATING ROAD NO. / HO-MODEL



Order no.
61034

Order no.
61035

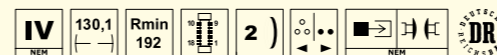

Diesel Locomotive 132 DR
See our website for road no.

DELIVERY DATE: SEE OUR WEBSITE

DEVIATING ROAD NO. / HO-MODEL



Order no.
61036

Order no.
61037

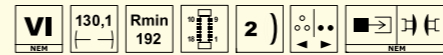

Diesel Locomotive 232 WFL
Road no. 232 601-5

DELIVERY DATE: SEE OUR WEBSITE

*

REAL ADDED VALUE: THE BRAWA WEBSITE



01 COMPREHENSIVE INFORMATION ON THE DETAILS OF THE MODEL VARIANTS WITH EXPLANATION OF ALL ICONS

02 INFORMATION ON AWARDS, HONOURS AND DISTINCTIONS RECEIVED BY MODELS

03 DETAILED DESCRIPTIONS OF THE MODEL DETAILS AND ADDITIONAL FUNCTIONS OF THE DIGITAL VERSION

04 FUNCTIONAL OVERVIEW OF THE MODEL VARIANTS

05 OPERATING INSTRUCTIONS WITH SPARE PARTS LISTS AND FUNCTION OVERVIEWS FOR DOWNLOAD



06 CONVENIENT "GOTO MENU" FOR FASTER NAVIGATION

07 INFORMATION ABOUT AND PHOTOS OF THE REAL STOCK OUR MODELS ARE BASED ON

08 CLEARLY ARRANGED LISTS OF ADDITIONAL MODELS OF THE SAME SERIES

09 INFORMATIVE PRODUCT AND WORKSHOP VIDEOS

10 PRODUCT RECOMMENDATIONS FOR ASSEMBLING TRAINS IN A HISTORICALLY ACCURATE MANNER

*

THE SYMBOLS AND THEIR MEANING

Era designation	Navigable minimum radius in mm	Locomotive has flywheel drive	The model has spring buffers
Direct current Analog	Can be switched over to overhead line operation	Double headlights alternating with the direction of travel	Replacement wheel set for AC (e. g. BRAWA product code 2180)
Direct current Analog BASIC	NEM 651 interface	Double headlights and one red taillight alternating with the direction of travel	AC pick-up can be retrofitted (e. g. BRAWA product code 2220)
Alternating current Analog BASIC+	NEM 652 interface	Triple headlights alternating with the direction of travel	Integrated sound
Alternating current Digital	Interface with soldering points	Triple headlights and two red taillights alternating with the direction of travel	Prepared for sound
Alternating current Digital EXTRA	Next 18 interface	Two red taillights	Vehicle predominantly in metal
Direct current Digital	21-pole interface	With interior lighting	Logo of the railway company (e. g. DRG)
Direct current Digital BASIC+	PluX22 interface	Interior lighting can be retrofitted (e. g. BRAWA product code 2200)	Digital Coupling
Direct current Digital EXTRA	Number of wheels with friction tyres	With interior fittings	Functional, switchable fan
Decoder Doehler & Haass	Locomotive has a smoke generator	The model has a coupler pocket but no short coupling cinematic	Energy Storage
Length over buffer in mm	Locomotive is prepared for the installation of a smoke generator (e. g. Seuthe No. 20)	The model has a coupler pocket and short coupling cinematic	

Products modifications are possible after this brochure is printed. Subject to modifications in design and shape. Colour deviations are possible.

Appenzeller, Aproz, Austria Glas Recycling GmbH, Bieres Mutzig, Brandt, Breisgau Milch, Ceskoslovenska Komise Cukerni v Praze, Chem. Werke Hüls Gesellschaft m.b.H. Marl, CSD, DB AG, DSB, Degussa, Dyckerhoff, Eisenacher Motoren Werke, Elefanten Schuhe, Elefantenbräu, Ermewa, Europ, EVA, Evian & Badoit, FS, Franken Zucker, Freiherrliche von Tucherische Brauerei Nürnberg, Frico, GATX, Glänzer (Erdal), Goggo, Gösser, Henniez Mineralwasser, Hoechst AG, Hyundai, Henkels IMI, Interfrigo, Kronenburg Biere d'Alsace, Kulmbacher Mönchshof Bräu, KVG, Leuna, Lloyd Triestino, Maggi, MAN, Mignon, MOL, Moser-Roth Schokolade, Niemetz Schwedenbomben, Paulaner, Peugeot Talbot, Pschorr, Quarzwerke, Rekord Briketts, RWE, Safmarine, Steyr Puch, Tetraethylblei, Transthermos Kühlverkehr, VEB schlichtwagen, VEB Synthesewerk Schwarzheide, Villeroy & Boch, VTG, Wiebe and Wieselburger are registered trademarks.

LIEBE ZUM DETAIL



CENTRE-DOOR COACH FOR THE
CITY EXPRESS TRAFFIC

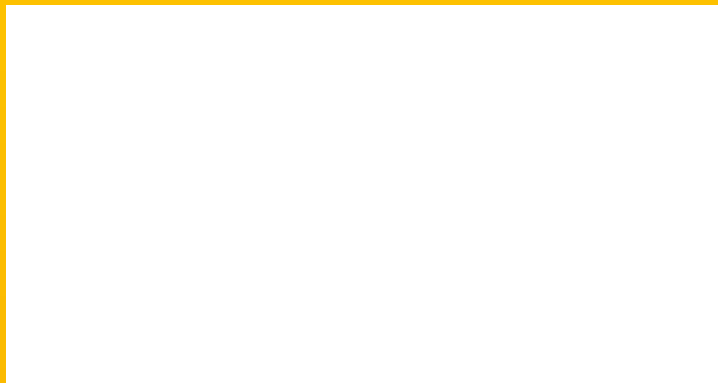

BRAWA Artur Braun Modellspielwarenfabrik GmbH & Co. KG . Uferstr. 24-30 . D-73630 Remshalden
Hotline: Monday – Thursday: 1 p.m. to 3 p.m. . Phone +49 7151 97935-68
Fax +49 7151 74662 . info@brawa.de . www.brawa.de



Order no. 0221.1